



KAWA

Części zamienne do urządzeń: MARCFI/ANCAS



GASTROPARTS Sp. J.

Klonowica 37
87-100 Toruń
tel. +48 56 657 00 68
fax +48 56 657 00 67
gastroparts@gastroparts.pl



Solenoid valves

Scem/Parker



Item	Order	Description
1	370057	cpl., 3 ways, 230V AC
2	370062	Solenoid square base
3	371029	Magnetic coil, 230V AC

Lucifer



Item	Order	Description
1	370053	cpl., 230V
2	370061	Solenoid square base
3	371031	Magnetic coil, 230V AC

ODE

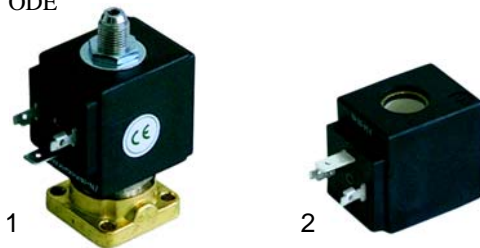

Item	Order	Description
1	370203	cpl., 3 ways, 230V AC
2	371150	Magnetic coil, 230V AC

Accessories



Item	Order	Description
1	371090	Plug
2	371095	O-ring (viton)
3	371100	O-ring (silicon)

Pressure switches, switches

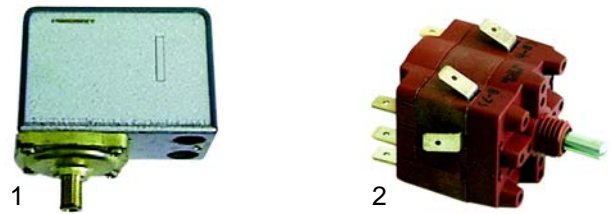

Item	Order	Description
1	541021	Pressure switch
2	346088	Main switch

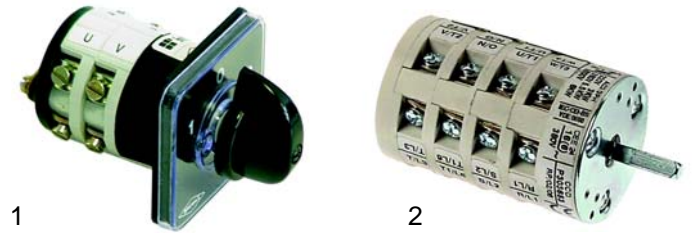

Item	Order	Description
1	346054	Main switch
2	346026	Main switch

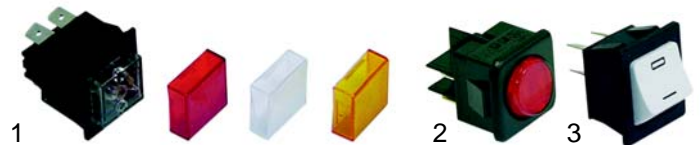

Item	Order	Description
1	345033	Switch, 2 poles, 27,2 x 22mm
1	345090	Push button, 2 poles, 27,2 x 22mm
2	345013	Switch, 2 poles, 26,5 x 25,6mm
3	301025	Switch, 2 poles, 28 x 24mm

Switches, lamps

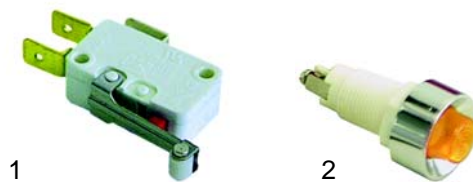

Item	Order	Description
1	345253	Micro switch
2	359417	Signal lamp, 230V

Elements

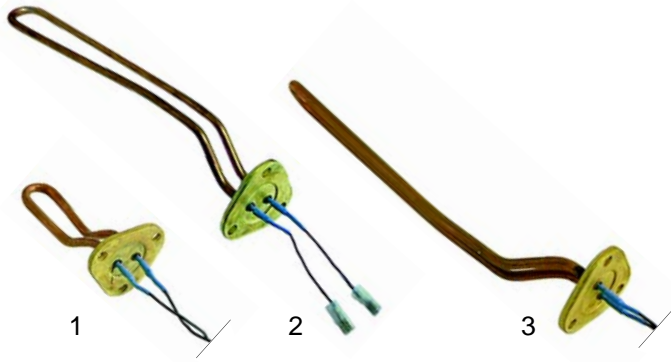

Item	Order	Description
1	417068	1 group, 600W, 230V
2	417069	2 groups, 1100W/400V
3	417070	2 groups, 1350W, 230V



Item	Order	Description
1	417071	1 group, 1000W, 230V
2	417072	2 groups, 3000W, 230V
3	417073	2 groups, 3000W/400V
4	528027	Element gasket

Manometers

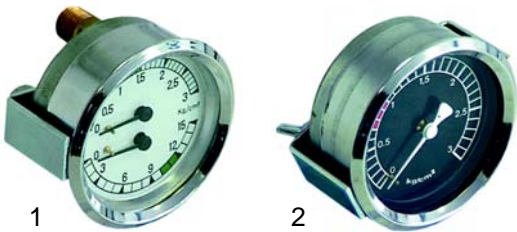

Item	Order	Description
1	541249	Manometer/double scale
2	541250	Manometer, 0 - 3 bar

Valves



Item	Order	Description
1	529312	Safety valve, 1,8 bar, 3/8"
2	529316	Safety valv/sealed, 1,8 bar, 3/8"
3	529303	Empty valve (stainless steel), 1/4"
4	529361	Cu-gasket, 1/4"
5	529349	Cu-gasket, 3/8"



Item	Order	Description
1	529324	Expansion- and retention valve/cpl.

Level glass

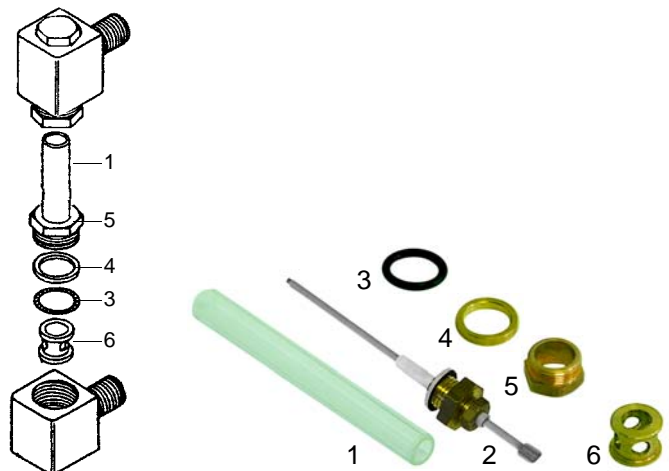

Item	Order	Description
1	529438	Level glass
2	400020	Level probe, 150mm
3	529439	O-ring
4	529440	Press washer
5	529441	Pipe upper nut
6	529442	Bush

Taps



Item	Order	Description
1	528782	Steam-/Water Tap/cpl.
2	111057	Knob
3	528783	Steam-/Water Tap/cpl.
4	111124	Knob

Pipes

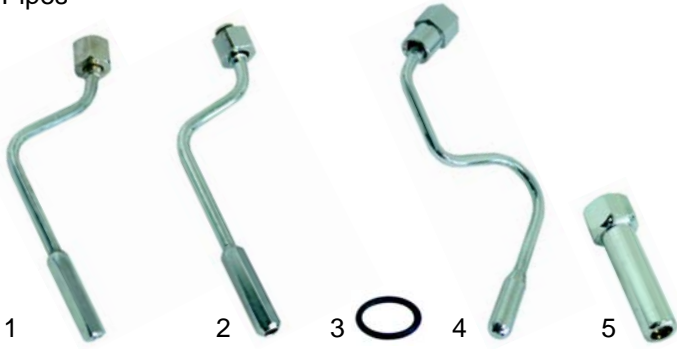

Item	Order	Description
1	529465	Steam pipe
2	529466	Water pipe
3	528744	O-ring
4	529467	Steam pipe
5	529468	Water pipe



Item	Order	Description
6	528784	Washer (aluminium)
7	528352	Spring
8	528786	Bush
9	529545	O-ring
10	529548	Gasket (teflon)

Group

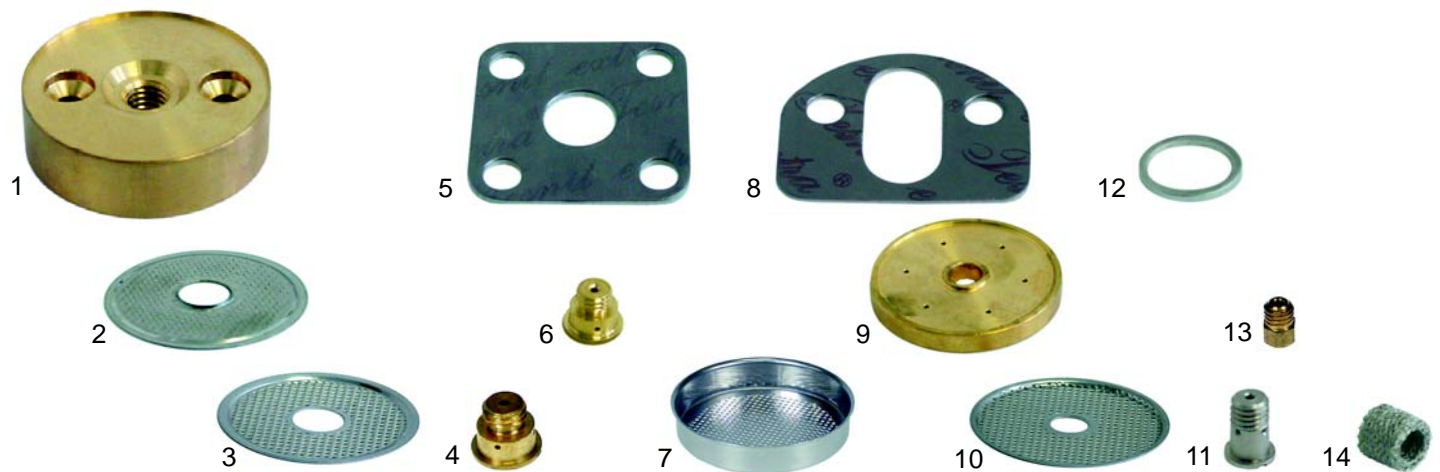
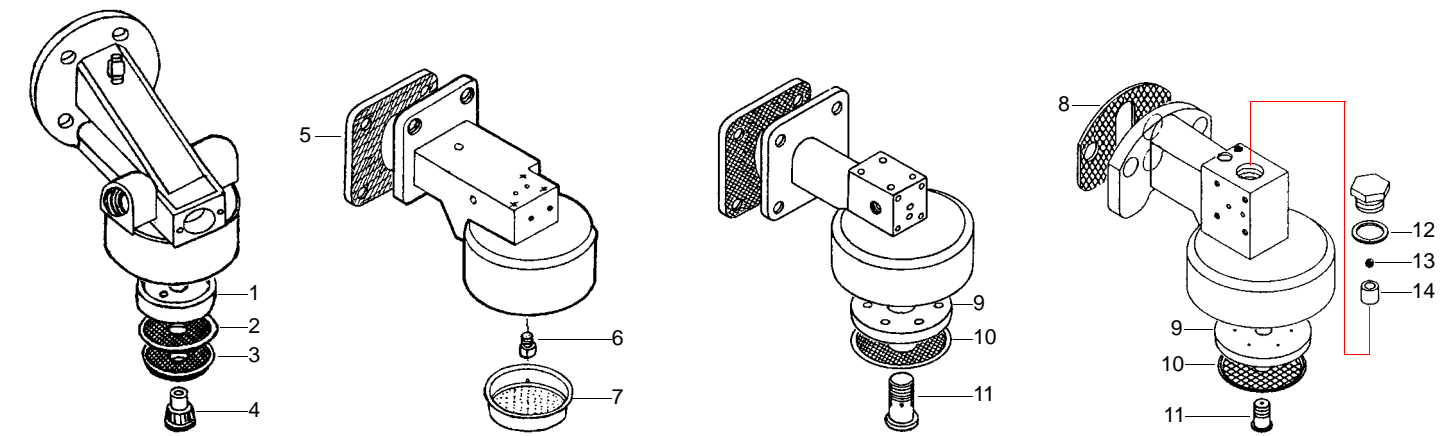

Item	Order	Description
1	529128	Dispersion
2	529136	Shower
3	529137	Shower
4	529149	Dispersion
5	529169	Gasket

Item	Order	Description
6	529135	Dispersion
7	529140	Shower
8	529189	Group gasket
9	529203	Dispersion
10	529138	Shower

Item	Order	Description
11	529139	Dispersion
12	528784	Washer (aluminium)
13	528787	Jet
14	528788	Filter

Filter holder gaskets



Item	Order	Description
1	528048	Space insertion, 64 x 53mm
2	528059	Filter holder gasket, 5,5 mm

Item	Order	Description
3	528060	Filter holder gasket, 7 mm
3	528061	Filter holder gasket, 8 mm

Item	Order	Description
4	529079	Filter holder spring

Filter holder gaskets, filter holder



Item	Order	Description
1	529153	Filter holder
2	529117	Filter holder handle

Item	Order	Description
3	529115	Filter holder handle

Filters



Item	Order	Description
1	529098	Filter, 1 cup (7g)
2	529099	Filter, 2 cups (14g)

Item	Order	Description
3	529102	Blank filter

Spouts



Item	Order	Description
1	529002	3/8", 1 way, straight/short
2	529001	3/8", 1 way, straight/long
3	529005	3/8", 1 way, curved/short
4	529003	3/8", 1 way, curved/long

Item	Order	Description
5	529004	3/8", 1 way, curved/closed
6	529008	3/8", 2 ways, distance 44mm
7	529007	3/8", 2 ways, distance 55mm/short
8	529006	3/8", 2 ways, distance 55mm/long



www.gastroparts.pl



GASTROPARTS Sp. J.

Klonowica 37
87-100 Toruń
tel. +48 56 657 00 68
fax +48 56 657 00 67
gastroparts@gastroparts.pl

