



KAWA

Części zamienne do urządzeń: EXPOBAR-CREM



GASTROPARTS Sp. J.

Klonowica 37
87-100 Toruń
tel. +48 56 657 00 68
fax +48 56 657 00 67
gastroparts@gastroparts.pl



EXPOBAR-CREM – ESPRESSO MACHINES

1
ESPRESSO MACHINES

SOLENOID GROUP

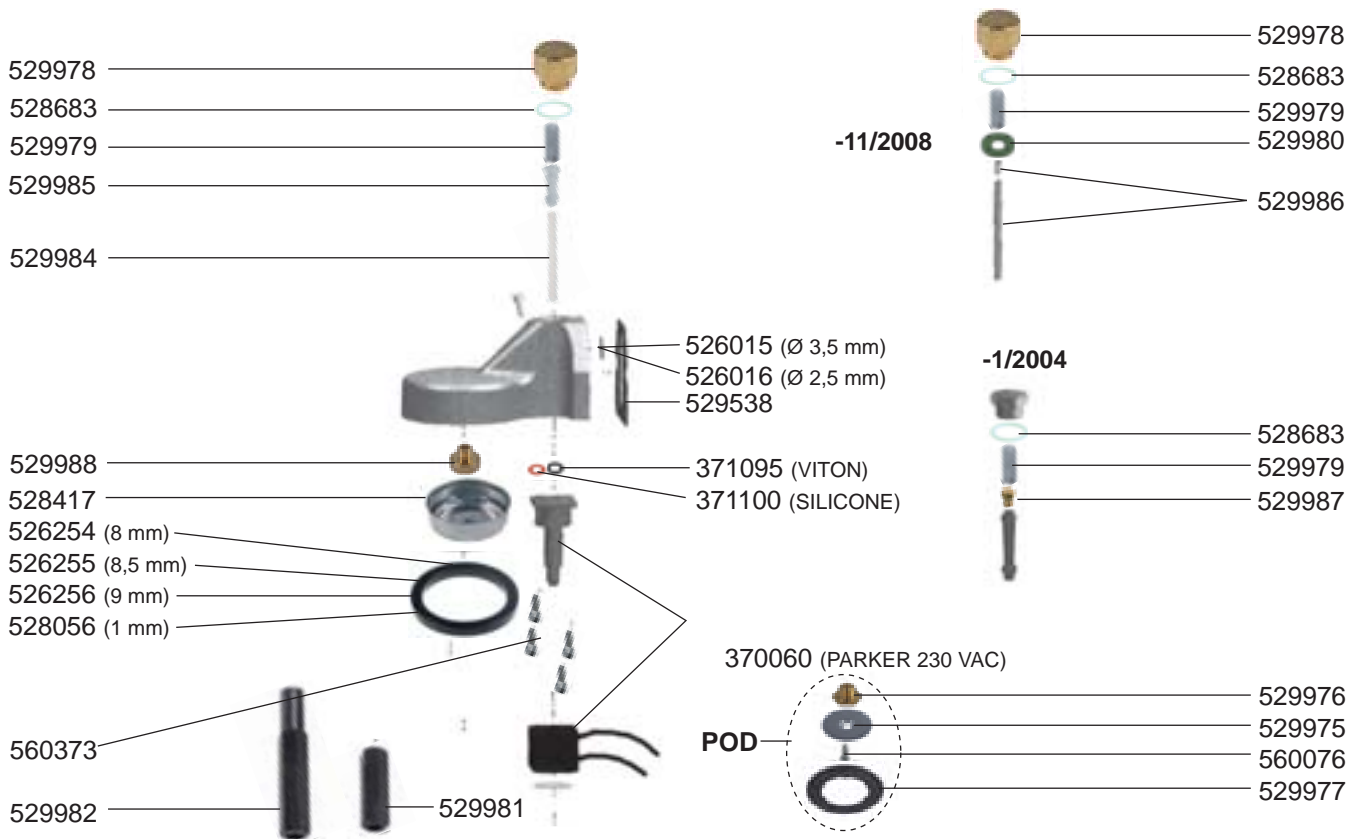

MANUAL GROUP

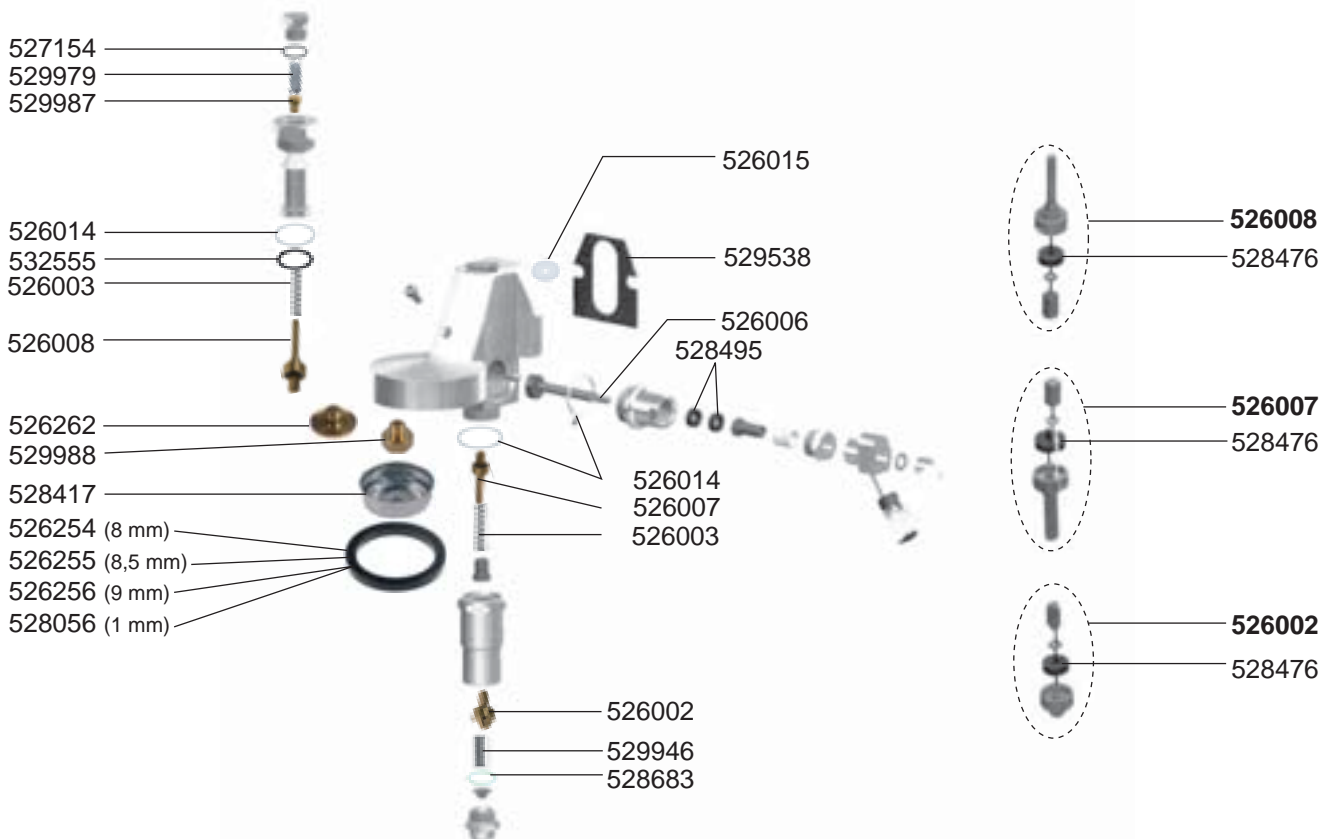

FILTER HOLDERS



STEAM/WATER ELEGANCE/MARKUS/MONROC/G10/MEGACREM/ELEN

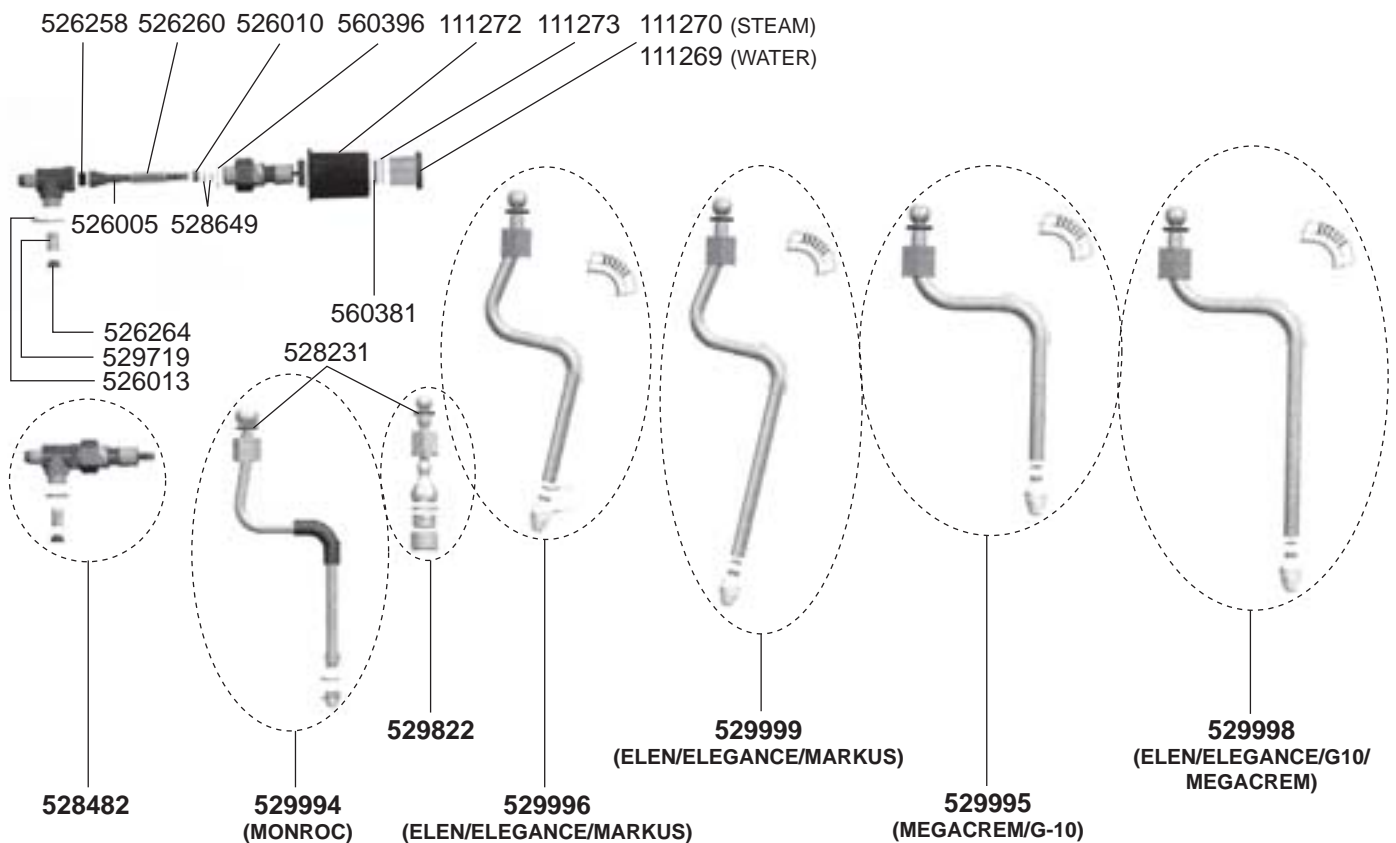

STEAM/WATER TAPS DIAMANT

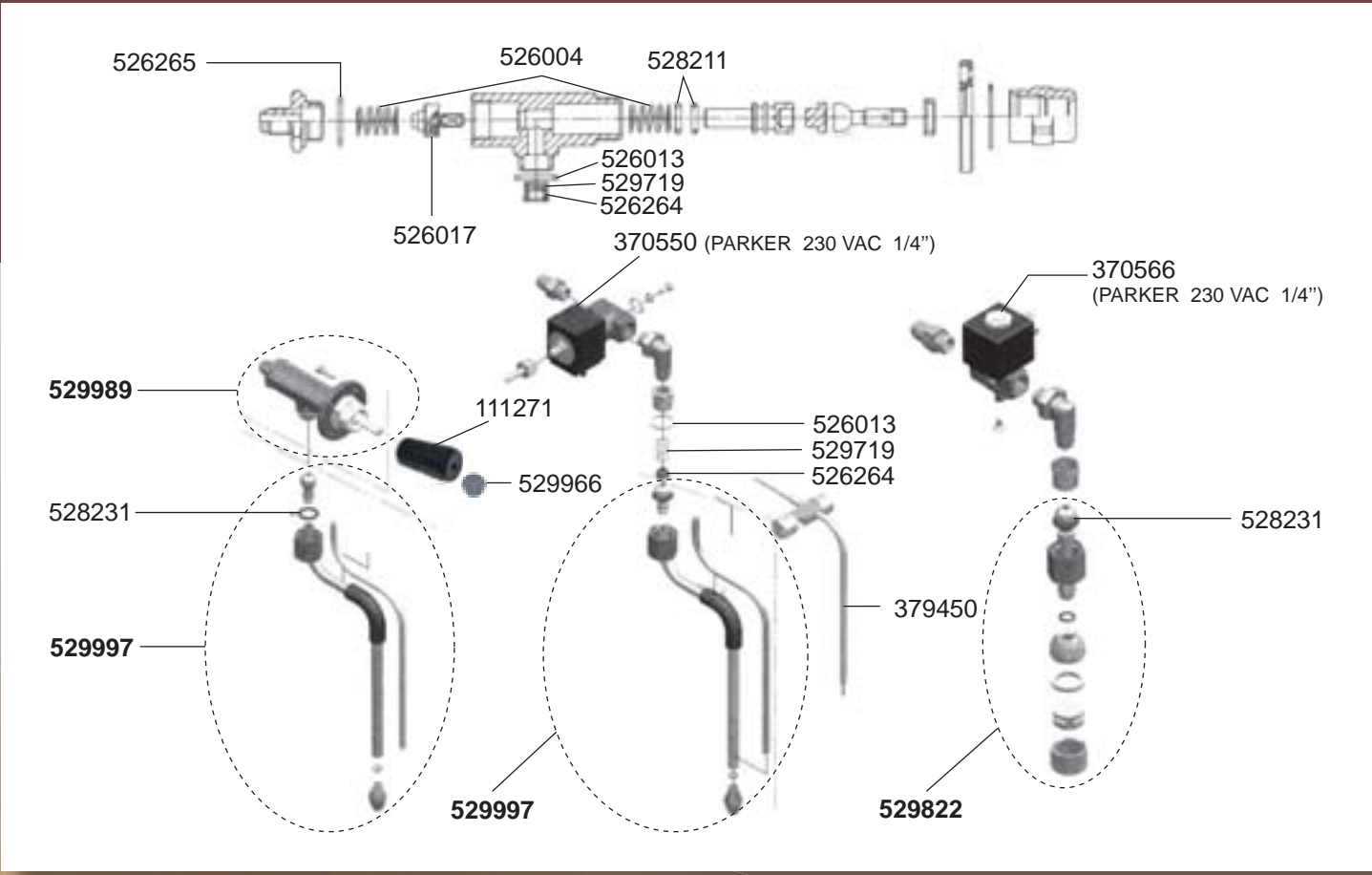

STEAM/WATER TAPS OFFICE/OFFICE LEVA

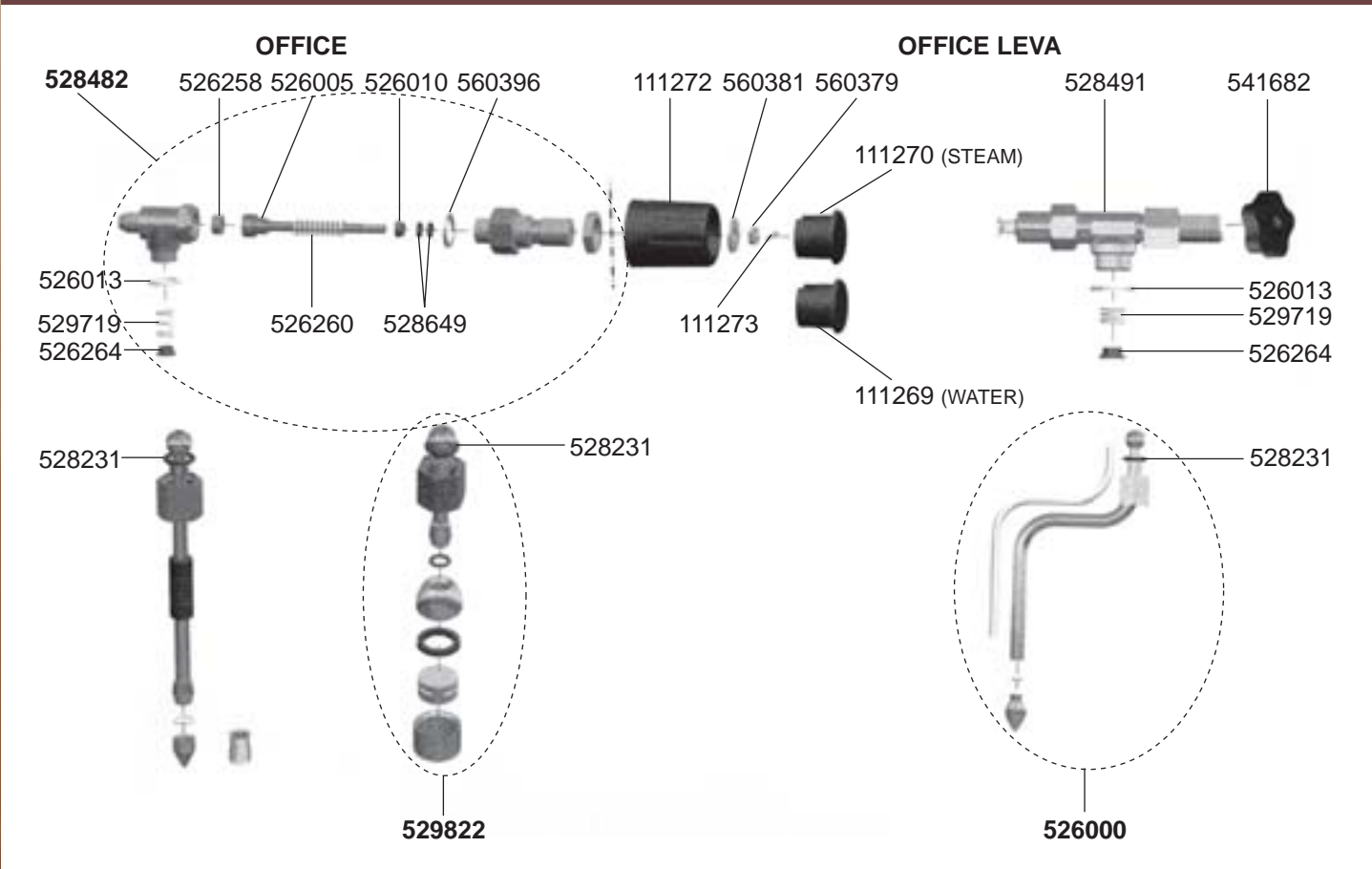

VALVES ELEGANCE/MARKUS

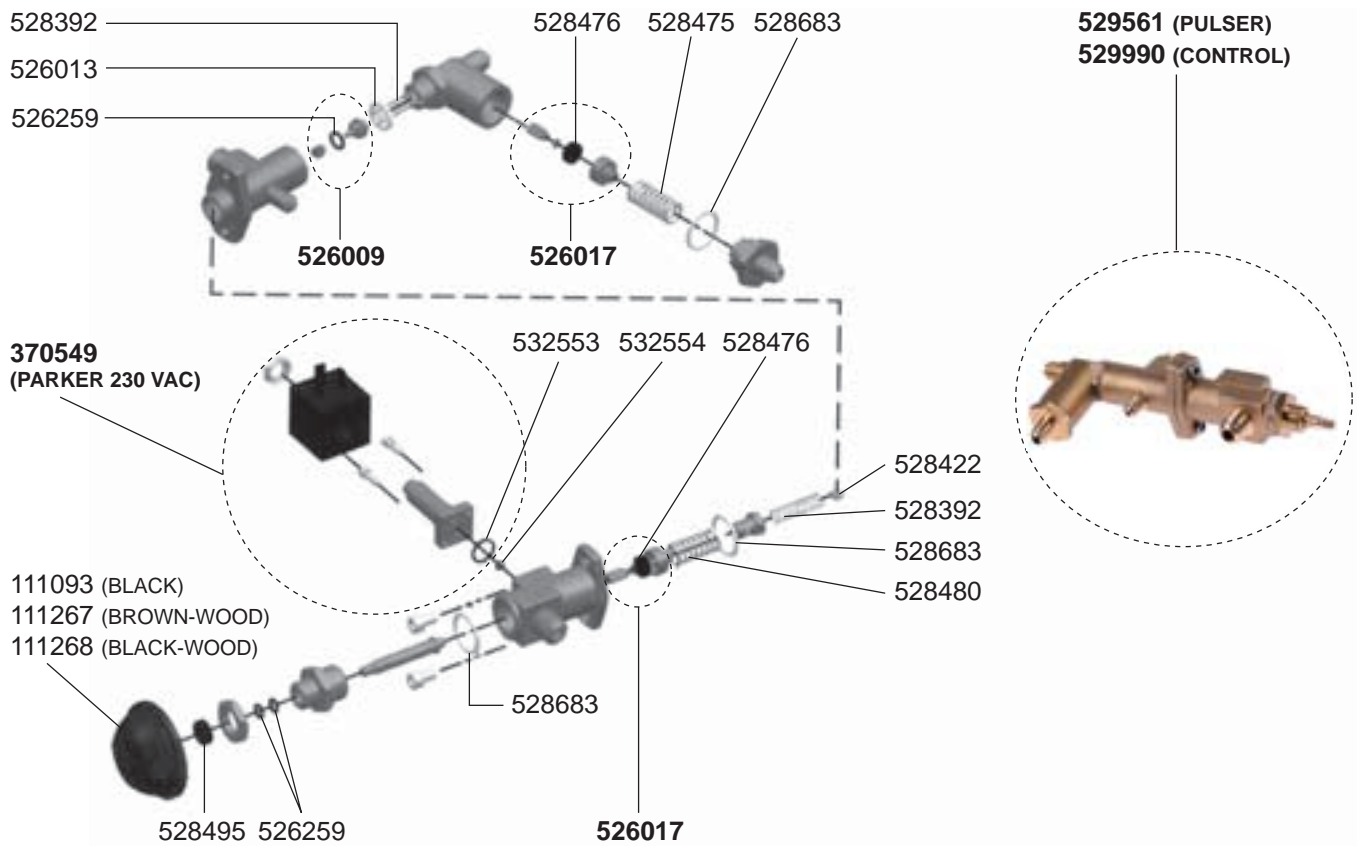

VALVES ELEGANCE/MARKUS/G10/MEGACREM/ELEN

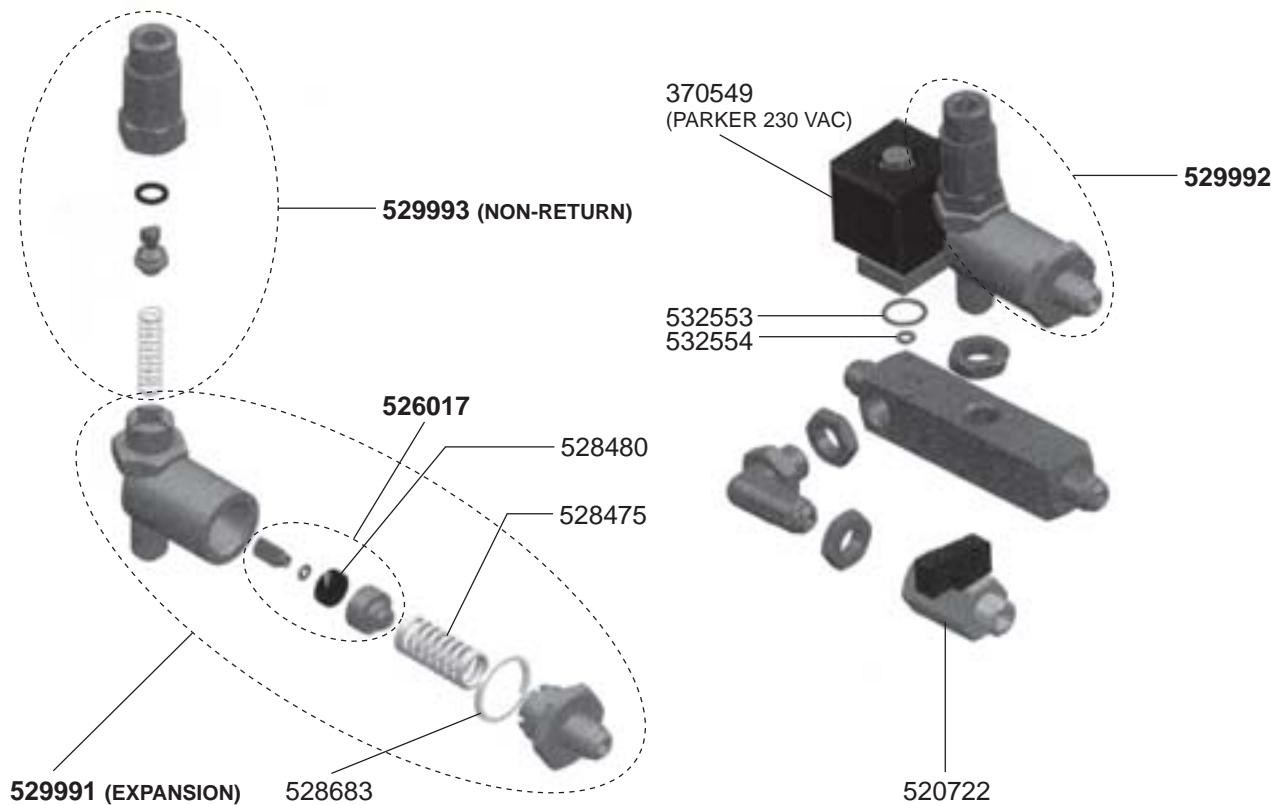

VALVES MONROC/DIAMANT

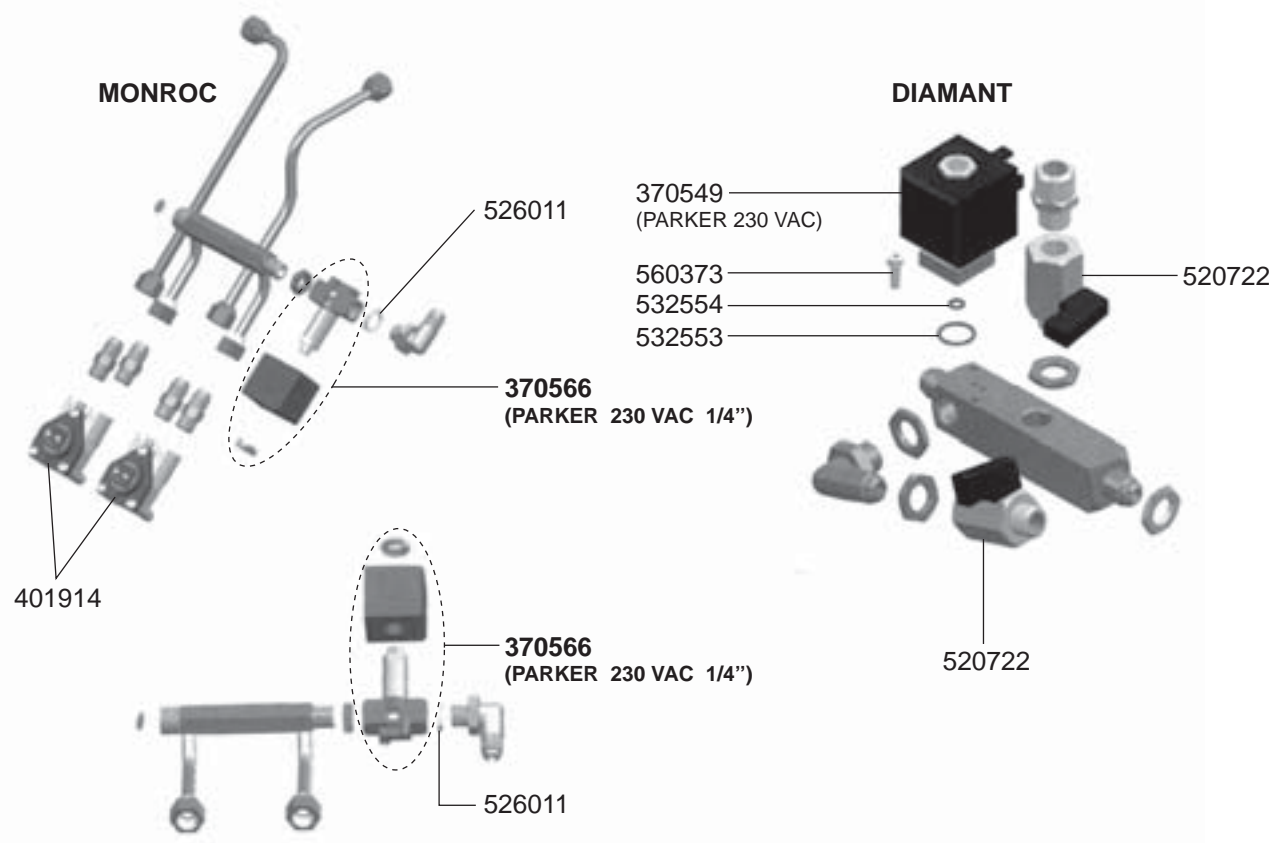

VALVES ELEGANCE MINI/MARKUS MINI/OFFICE

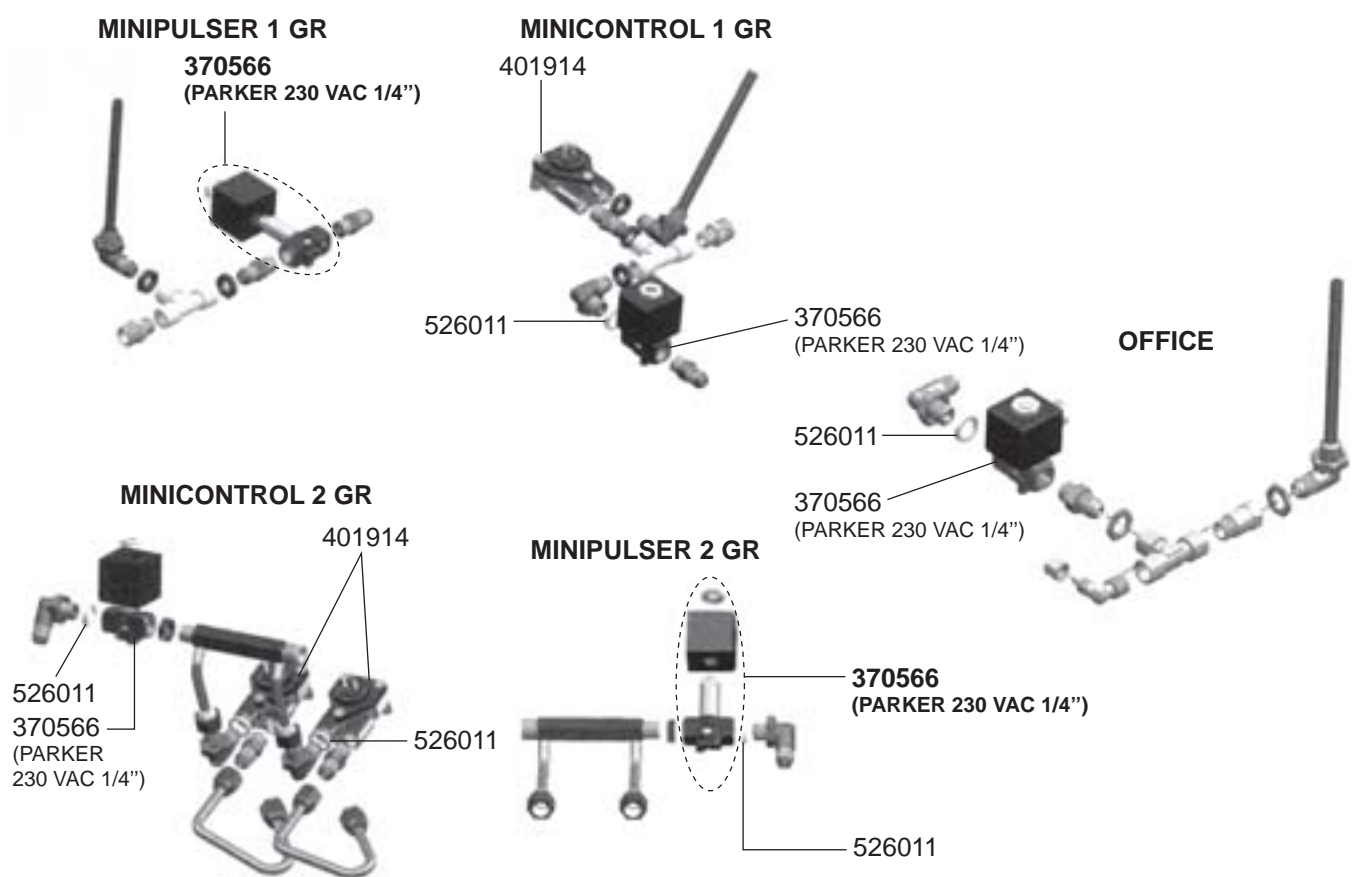

LEVEL INDICATOR

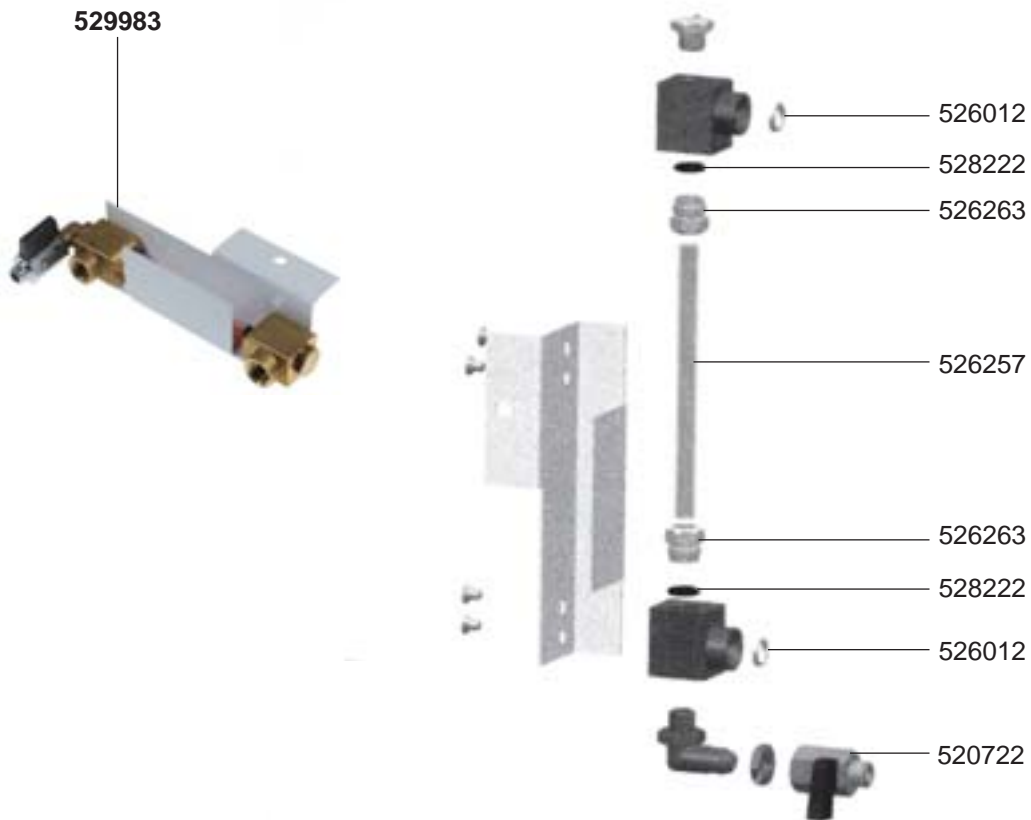

BOILER/MANOMETERS/DRIP TRAYS VARIOUS





















MARKUS/ELEGANCE/MEGACREM



EXPOBAR-CREM – ESPRESSO MACHINES

1
ESPRESSO MACHINES

ELECTRICAL COMPONENTS ELEGANCE/MARKUS

 529932 (GICAR REF. 9.5.28.66G00)	 529934 (GICAR REF. 9.5.28.68G00)	 529963 (BRONZE)	 529964 (RED)	 529965 (CARBON)	 400652 (GICAR REF. 9.5.28.28G00)
 400655 (GICAR REF. 9.5.28.30G00NEW)	 529947 (WOOD) (GICAR REF. 9.5.28.28G00)	 529931 (WOOD) (GICAR REF. 9.5.28.30G00NEW)	 400653 (GICAR REF. 9.5.27.60)	 529944 (BLACK)	 529943 (WOOD)
 529945 (BLACK)	 400657	 402705 (MARKUS) (BLACK)	 402706 (MARKUS) (WOOD)	 529962 (MARKUS) (BLUE)	 529961 (MARKUS) (WOOD)
 529951 (LUX/GICAR REF. 9.5.25.50G01)	 529950 (XLC/GICAR REF. 9.5.32.01G01)	 529954	 529968 (GIEMME REF. 01.00.0029)	 402222	 402223

ELECTRICAL COMPONENTS ELEGANCE/MARKUS/MONROC

ELEGANCE/MARKUS

 347254 (0-1 2 GR)	 346104 (0-1 3 GR)	 347198 (4 POLES)	 359471 (RED)	 301001 (RED)	 346377 (BLACK)
 379452		 541684 MONROC			
 529937 (GICAR REF. 9.9.07.28G)	 301001 (RED)	 346377 (BLACK)	 529950 (GICAR REF. 9.5.32.01G01)	 529968 (GIEMME REF. 01.00.0029)	 359471 (RED)
 402222	 541684				

ELECTRICAL COMPONENTS MEGACREM



529938
(GICAR
REF. 9.5.28.61G00)



529967
(GICAR
REF. 9.5.28.59G00)



529951
(3D5 LUX/GICAR
REF. 9.5.25.50G01)



529939
(3D5/GICAR
REF. 9.9.07.66G)



402224



379452



529968
(GIEMME REF. 01.00.0029)



402223
(3-32 V)



402222
(90-280 V)



347254
(0-1/2 GR)



346104
(0-1/3 GR)



347198
(4 POLES)



359471
(RED)



301001
(RED)



346377
(BLACK)



301086
(BLACK)



541684

ELECTRICAL COMPONENTS G10/ELEN



529937
(GICAR REF. 9.9.07.28G)



529951
(3D5 LUX/GICAR
REF. 9.5.25.50G01)



402224

G-10



529957



379452



529936
(GICAR
REF. 9.5.28.84G00)



379445



402223 (4-32 V)



402222 (90-280 V)



347254 (0-1/2 GR)



346104 (0-1/2 GR)



347198
(4 POLES)



359471 (RED)



301001 (RED)



346377 (BLACK)



541684

ELEN



529941



529951
(3D5 LUX/GICAR REF. 9.5.25.50G01)



529950
(3D5 XLC/GICAR REF. 9.5.25.50G01)



529940
(GICAR REF. 9.5.32.01G01)



529958



379452

ELECTRICAL COMPONENTS ELEN/DIAMANT

ELEN



DIAMANT



ELECTRICAL COMPONENTS DIAMANT/OFFICE LEVA/OFFICE

DIAMANT



OFFICE LEVA



OFFICE



ELECTRICAL COMPONENTS VARIOUS



400004



400256



400257



400258



541021
(SIRAI, 30 AMP,
3 POLES)



541724
(SIRAI, 20 AMP,
3 POLES)



541723
(SIRAI, 20 AMP,
2 POLES)



541453
(PARKER)



370057
(PARKER 230 VAC)
370053
(LUCIFER 230 VAC)



370062
(PARKER)
370061
(LUCIFER)



370206
(PARKER 230 VAC 1/8")
370072
(LUCIFER 230 VAC 1/8")



371029
(PARKER 230 VAC)
371031
(LUCIFER 230 VAC)



371091



371090



371095
(VITON)



371100
(SILICONE)



www.gastroparts.pl



GASTROPARTS Sp. J.

Klonowica 37
87-100 Toruń
tel. +48 56 657 00 68
fax +48 56 657 00 67
gastroparts@gastroparts.pl

