



CHŁODNICTWO

Części zamienne do kostkarek: TECNODOM



GASTROPARTS Sp. J.

Klonowica 37
87-100 Toruń
tel. +48 56 657 00 68
fax +48 56 657 00 67
gastroparts@gastroparts.pl





heating elements

heating elements for refrigeration

heating elements for defrosting



Part No.	420481	Ref. No.	AF52RESEV0607 RCSE700BTMN
description	heating element 360W 230V L 260mm W 75mm H 42mm connection female faston 6.3mm cable length 900mm tube ø 8.5mm		

heating elements for condensate evaporation



Part No.	420480	Ref. No.	AF17RESVASC RCVEC92510W
description	heating element 150W 230V L 420mm W 70mm cable length 250mm connection distance 70mm connection male faston 6.3mm tube ø 8.5mm		

heating cables

connection on both sides

with wire end ferrules



Part No.	420479	Ref. No.	AF10RESPO RFPAC5700
description	heating cable 52W 230V L 5700mm L1 (unheated) 2x730mm L2 (heated) 4240mm silicone ø 2.7mm		

thermostats

control and safety thermostats

CAEM

control thermostats

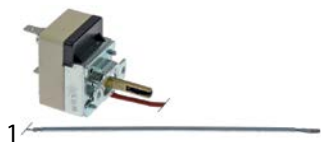

Part No.	390790	Ref. No.	HETFR50-280
description	thermostat t.max. 300°C temperature range 50-280°C 1-pole 1NO 16A probe ø 3mm probe L 160mm capillary pipe 1450mm capillary pipe isolated 650mm gland nut shaft ø 6x4.6mm shaft L 22mm rotation 270° 250V		

switches and momentary switches

rocker/momentary rocker switches

30x22mm



Part No.	301003	Ref. No.	AF30INT
description	rocker switch mounting measurements 30x22mm green 2NO 250V 16A illuminated 0-I connection male faston 6.3mm ambient temperature max. 125/55°C protection IP65		
accessories for	301003		
	Part No.	301036	Ref. No. —
	protective cover internal size 30x22mm for rocker switch mounting measurementsmm		

probes

universal probes

temperature probes



Part No.	379053	Ref. No.	ATserie
description	temperature probe PTC 1kOhm cable PVC probe -50 up to +150°C cable -10 up to 100°C probe ø6x30mm cable length 3m without screw connection 2-wire		

core probes



Part No.	379549	Ref. No.	SONCU
description	core temperature probe PTC 1kOhm cable PVC probe -50 up to +150°C cable -10 up to 100°C probe ø6x110mm cable length 3.5m handle ø 8mm handle length 120x35mm 2-wire L1 120mm L2 130mm		



producer-specific probes

core probes

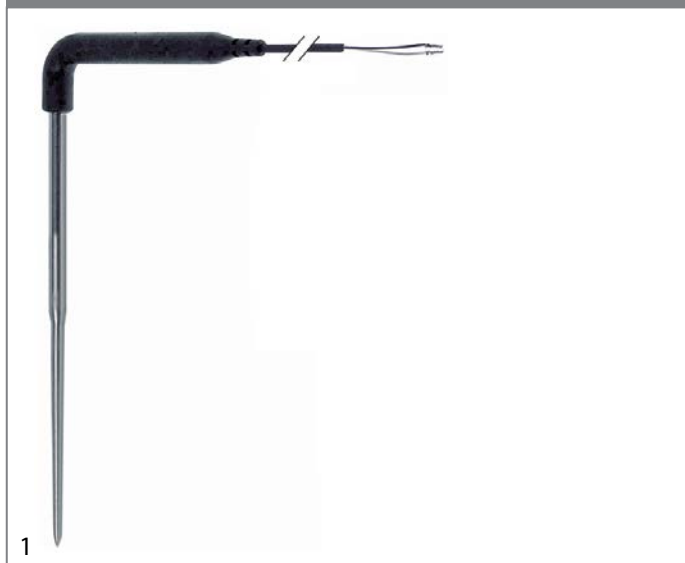

1	Part No.	379549	Ref. No.	SONCU
	description	core temperature probe PTC 1kOhm cable PVC probe -50 up to +150°C cable -10 up to 100°C probe ø6x110mm cable length 3.5m handle ø 8mm handle length 120x35mm 2-wire L1 120mm L2 130mm		

electronics

PCBs



1	Part No.	403887	Ref. No.	SCDAB3/5T
	description	electronic controller for deep freezer L 105mm W 95mm		

compressors

ACC/ZEL

R404a/R507

HMBP monophase

High/Medium evaporation temperature above -20/-15 °C



1	Part No.	605068	Ref. No.	AF82ML45TB AF82ML45TG
	description	compressor coolant R404a/R507 type ML45TB 220-240V 50Hz HMBP fully hermetic 10kg 1/5HP cylinder capacity 4.5cm ³ CSIR H 175.5mmW 192W 246W 309W 382W 465W 557W 659W 771W test method ASHRAE		



1	Part No.	605014	Ref. No.	AF82ML80TB
	description	compressor coolant R404a/R507 type ML80TB 220-240V 50Hz HMBP fully hermetic 11.4kg 3/8HP cylinder capacity 7.57cm ³ CSIR H 175.5mmW 261W 346W 446W 561W 691W 835W 993W 1167W test method ASHRAE ambient temperature max. 43°C		





fans

axial fans

import



1

Part No.	601080 ¹	Ref. No.	VENTILATORECOMP
description	axial fan L 119mm W 119mm H 38mm 230VAC 50/60Hz 23/20W bearing ball bearing connection male faston 2.8mm metal ADDA fan wheel ø 110mm temp.-resist. 70°C		
accessories for	601080		
	Part No.	550898	Ref. No. —
	connecting cable cable length 2000mm connection F 2.8 connection distance 7.9mm for axial flow fan		
	Part No.	692519	Ref. No. —
	guard L 120mm W 120mm plastic		

¹with ball bearings

refrigeration fans

refrigeration motors universal

accessories

fan wheels

aluminium

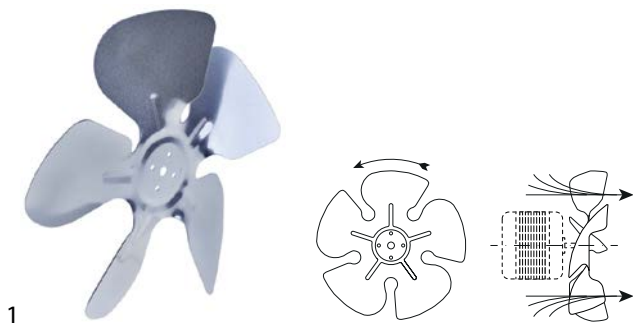

1

Part No.	601571	Ref. No.	AF83VENCOND
description	fan wheel blowing ø 230mm fan wheel mounting 25.4mm blade angle 28° W 43mm aluminium		

cold air circulating fans (complete)

ebm-papst

A4E series

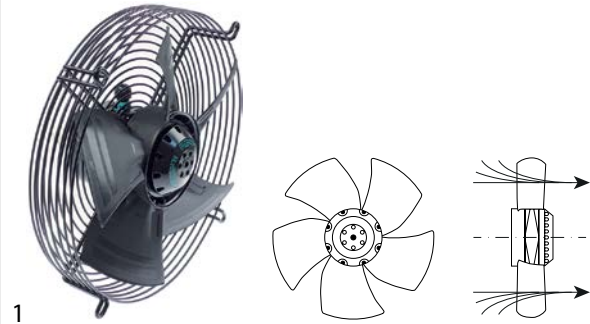

1

Part No.	602049	Ref. No.	VENTBAST
description	fan A4E300-AS72-06 fan wheel ø 300mm blades 5 230V 50/60Hz 72/90W ø 340mm mounting distance 265mm 1320/1500rpm cable lengthmm ebm-papst		

cross flow fans

COPREL

with moulded coils



1

Part No.	602104	Ref. No.	N/A
description	cross flow fan COPREL FFL roller ø 60mm roller length 240mm laminated core thickness 20mm motor position left 230V/50-60Hz 26W universal bearing silicone connection cable 500mm airflow 149m³/h -10 up to +50°C		



hinges

spring assisted hinges

universal

INTERKLIMAT

hinges

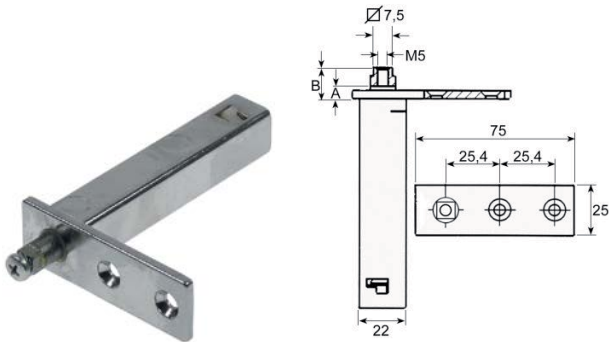

1

Part No.	690622	Ref. No.	AF07CERN AF07CERN 10 AFCERN1400
description	spring assisted hinge series 28L mounting pos. left/right L 75mm W 25mm H 103mm A 13mm B 18mm mounting measurements 22x22mm intake 7.5x7.5 refrigeration units		

oven hinges

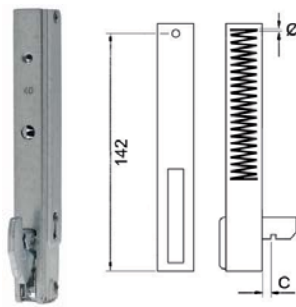

1

Part No.	700390	Ref. No.	HCFO3GN7741 HCFO4NE6843 HCFONE595 HCFONEPAST
description	oven hinge mounting distance 142mm mounting distance 2mm lug mountingmm lever lengthmm groove distance 12mm spring thickness 3mm mounting ear position spring length 116mm L 170mm mounting pos. left/right W 22mm		

accessories

miscellaneous



1

Part No.	701619	Ref. No.	TZXXA056SX
description	bracket for hinge L 120mm		

shelves and shelf rails

grates

universal

without upstand



1

Part No.	970896	Ref. No.	GRPL600
description	grate W 530mm D 550mm H 10mm plastic-coated steel wire gauge frame 8mm lengthwise wires gauge 3mm crossing wires 2 grey		

shelf rails and supports

producer-specific



1

Part No.	701483	Ref. No.	GL700
description	pair of setting bar L-shape L 650mm W 24mm H 28mm mounting pos. left/right		



1

Part No.	692619	Ref. No.	GC700
description	pair of setting bar U-shape L 650mm W 14mm H 28mm mounting pos. left/right		



gaskets

refrigeration gaskets

plug-in gaskets

profile 9048

We offer custom-made gaskets for this profile

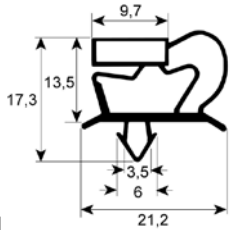

1

Part No.	900944	Ref. No.	GC3CTGN
description	refrigeration gasket profile 9048 W 387mm L 177mm plug size		

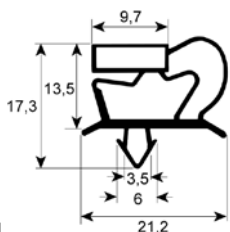

1

Part No.	900945	Ref. No.	GC2CTGN
description	refrigeration gasket profile 9048 W 387mm L 292mm plug size		

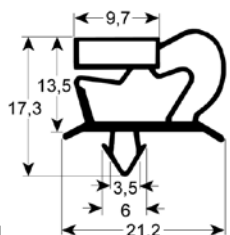

1

Part No.	902063	Ref. No.	GPTGN
description	refrigeration gasket profile 9048 W 387mm L 633mm plug size		

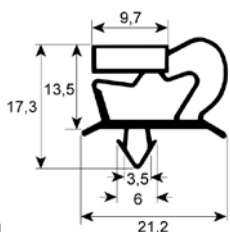

1

Part No.	900947	Ref. No.	GPTPA
description	refrigeration gasket profile 9048 W 455mm L 635mm plug size		

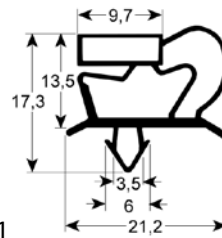

1

Part No.	902110	Ref. No.	GPA400
description	refrigeration gasket profile 9048 W 540mm L 1390mm plug size		

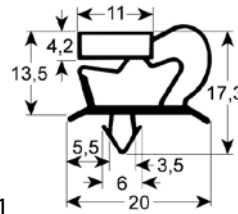

1

Part No.	902467	Ref. No.	GSA
description	refrigeration gasket profile 9048 W 621mm L 742mm plug size		

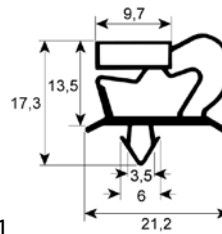

1

Part No.	900949	Ref. No.	AF07-013 AF09GUAPO AF14-013 AF14EKOMBT GPA GPA Pos. 13
description	refrigeration gasket profile 9048 W 627mm L 1545mm plug size		

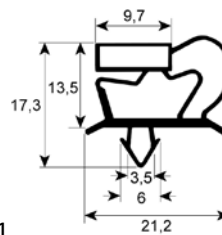

1

Part No.	900948	Ref. No.	AF08GUASP AF09GUASP
description	refrigeration gasket profile 9048 W 637mm L 742mm plug size		

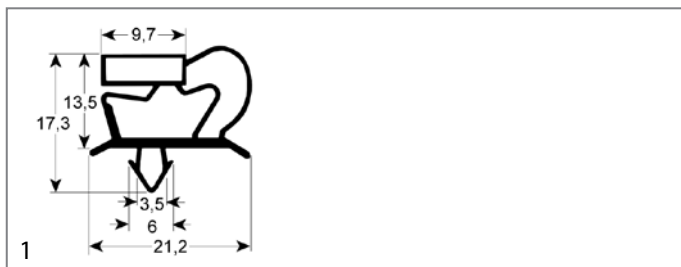

Part No.	902258	Ref. No.	N/A
description	refrigeration gasket profile 9048 Wmm L 2500mm plug size		



www.gastroparts.pl



GASTROPARTS Sp. J.

Klonowica 37
87-100 Toruń
tel. +48 56 657 00 68
fax +48 56 657 00 67
gastroparts@gastroparts.pl

